

Start Here

EPSON Perfection® 4870 Photo

1 Unpack Your Scanner

1 Make sure you have all the parts shown below for your EPSON® scanner:

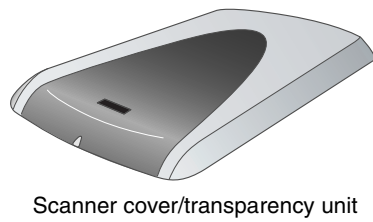
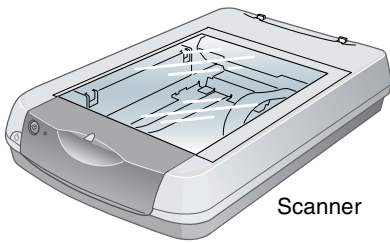

CD-ROM with EPSON Scan driver, software, and electronic manuals

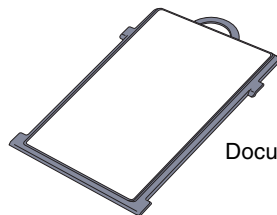

Adobe® Photoshop® Elements 2.0 CD-ROM

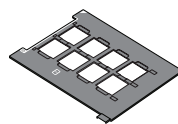

LaserSoft® SilverFast® CD-ROM

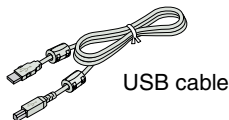
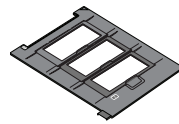
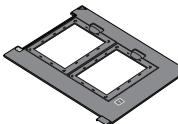

Film holders

Note: If you'll be connecting your scanner using IEEE 1394 (FireWire® or iLink™), you'll need to purchase an IEEE 1394 cable (not included).

2 Remove all the packing tape, but leave the large stickers in place until you are instructed to remove them.

IMPORTANT!
Leave the sticker in place until you are instructed to remove it

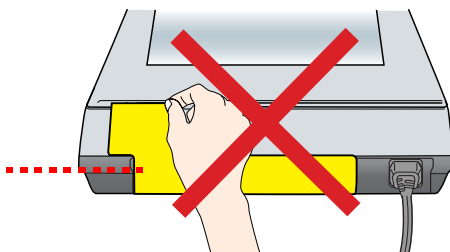

3 Insert the hinges on the cover into the square holes at the back of the scanner.

4 Remove the sticker, then slide the transportation lock to the unlocked position.

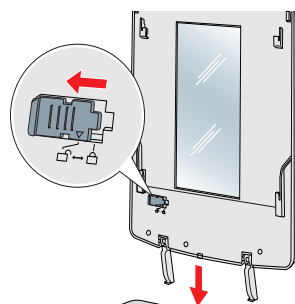

5 Attach the document mat. Hold the top of the document mat and slide it down gently along the document cover. Make sure the tabs on the bottom and sides of the document mat fit in the slots on the document cover.

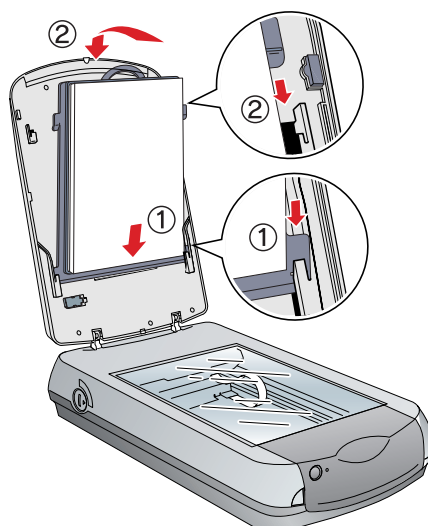
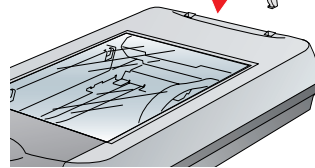

6 Close the cover.

2 Install the Software

Wait! You must install your software before connecting the scanner to your computer. The installation process may take several minutes. Be sure to close all open programs and turn off any virus protection programs.

The software works with Windows® 98, Me, 2000, and XP, and Macintosh® OS 8.6 to 9.x and OS X 10.2.x. Follow the steps below (for Windows), or the steps in the next column (for Macintosh).

Note: If you don't already have Adobe Photoshop or Photoshop Elements on your computer, install Photoshop Elements from the CD-ROM included with your scanner.

Windows

First you'll install Adobe Photoshop Elements, then your scanner software, and finally SilverFast.

Photoshop Elements

- 1 Insert the Adobe Photoshop Elements CD-ROM in the CD-ROM or DVD drive. The installer starts automatically. At the first screen, click **Next**.
- 2 Make sure **US English** is selected and click **Next**.
- 3 Follow the on-screen instructions to begin installation and accept the software license conditions.
- 4 When you see this screen, click the **Adobe Photoshop Elements** button.

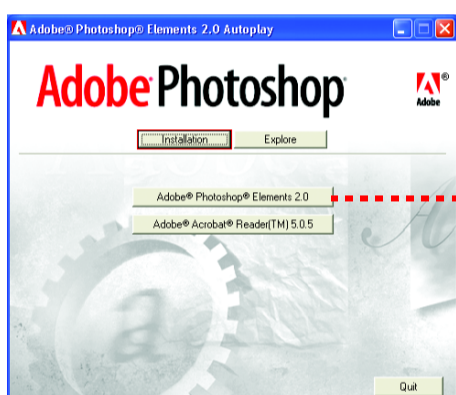

Click **Adobe Photoshop Elements**

- 5 Follow the on-screen instructions. When you're asked for a serial number, enter the number printed on the sticker attached to the CD-ROM sleeve.
If you don't have Acrobat Reader®, eject the CD-ROM and repeat steps 1 to 3. Then select **Adobe Acrobat Reader** to install it.

Remove the CD-ROM and install the scanner software as described below.

Scanner Software

- 1 Insert the scanner software CD-ROM in the CD-ROM or DVD drive. The installer starts automatically. If it doesn't start, do the following:
 - Windows XP: Click **Start**, click **My Computer**, then double-click the **EPSON CD-ROM** icon.
 - Windows 98, Me, and 2000: Double-click  **My Computer**, then double-click the **EPSON CD-ROM** icon.
- 2 At the language selection screen, select your preferred language.
- 3 When you see the antivirus software message, click **Continue**.
- 4 Read the license agreement, then click **Agree** to continue.
- 5 At the Software Installation screen, click **Install**. The software installs automatically.



Click **Install**

- 6 At the end of the installation, click **Exit**.
- 7 Register your scanner when prompted, then remove the CD-ROM.

[Continue with the instructions](#) in the next column to install SilverFast.

SilverFast

- 1 Insert the LaserSoft SilverFast SE CD-ROM in the CD-ROM or DVD drive. The installer starts automatically.
- 2 Choose your language from the pull-down menu.
- 3 Click the **Install SilverFast** icon.



Click this icon

- 4 Select the type of plug-in you want to install:
 - Photoshop plug-in installer (for Adobe Photoshop or Photoshop Elements), recommended
 - TWAIN plug-in installer (for other TWAIN-compliant applications)
- 5 Click **Begin Installation**, read the license agreement and click **Yes**, then follow the steps on the screen to finish the installation.



Remove the CD-ROM and continue with the instructions on the back of this sheet to connect the scanner.

Macintosh

Note: EPSON Scan does not support the UNIX® File System (UFS) for Mac® OS X. You must install the software on a disk or in a partition that does not have UFS.

First you'll install Adobe Photoshop Elements, then your scanner software, and finally SilverFast.

Photoshop Elements

- 1 Insert the Adobe Photoshop Elements CD-ROM in the CD-ROM or DVD drive.
- 2 Double-click the  or  CD-ROM icon and double-click the  English folder.
- 3 Double-click the **Install Photoshop Elements** icon.
- 4 Follow the on-screen instructions to begin installation, and accept the software license conditions. In Mac OS X, enter your administrator name and password, then click **OK**.
- 5 When you're asked for a serial number, enter the number printed on the sticker attached to the CD-ROM sleeve.
- 6 When you see this screen, click the **Install** button.

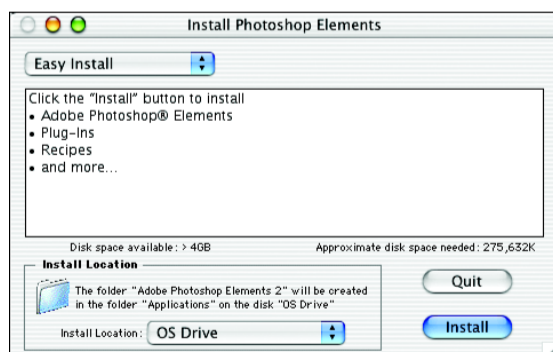

- 7 Follow the on-screen instructions to install the software.
- 8 When you're finished, click **Quit**.
- 9 If you don't have Acrobat Reader, you can install it from the CD-ROM. Open the Adobe Acrobat Reader folder. Then double-click the **Reader Installer** icon to install it.

Remove the CD-ROM and continue with the following instructions to install the scanner software.

Scanner Software

- 1 Insert the scanner software CD-ROM in the CD-ROM or DVD drive. Double-click the  **EPSON** CD-ROM icon, if necessary.
- 2 Double-click the **EPSON** icon.
- 3 At the language selection screen, select your preferred language.
- 4 When you see the antivirus software message, click **Continue**.
- 5 Read the license agreement, then click **Agree** to continue.
- 6 At the Software Installation screen, click **Install**. Enter your administrator name and password, if necessary.



Click **Install**

Note: If you're installing on Macintosh OS 8.6 to 9.x, you may see a prompt to update your Carbon Library. After the CarbonLib installation is complete and you've restarted your system, double-click the  **EPSON** icon, then follow the steps above to continue the installation.

- 7 Follow the on-screen instructions to install the software. If you are prompted to restart, click **Quit**.
- 8 At the end of the installation, click **Exit**.
- 9 Register your scanner when prompted, then remove the CD-ROM.

Continue with the instructions below to install SilverFast.

SilverFast

- 1 Insert the LaserSoft SilverFast SE CD-ROM in the CD-ROM or DVD drive. The installer starts automatically.

In Mac OS X (or on systems where the installer doesn't start automatically), double-click the **Installer** icon in the CD-ROM window.

- 2 Choose your language from the pull-down menu.
- 3 Click the **Install SilverFast** icon.



Click this icon

- 4 Click **Begin Installation**.
- 5 Read the license agreement and click **Accept**, then follow the steps on the screen to finish the installation.

Remove the CD-ROM and restart your system. Then follow the instructions on the back of this sheet to connect the scanner.

3

Connect the Scanner

After your software is installed, it's time to connect your scanner.

- 1 Remove the sticker from the transportation lock. Use a coin to turn the lock clockwise one-quarter turn to unlock the scanner carriage.

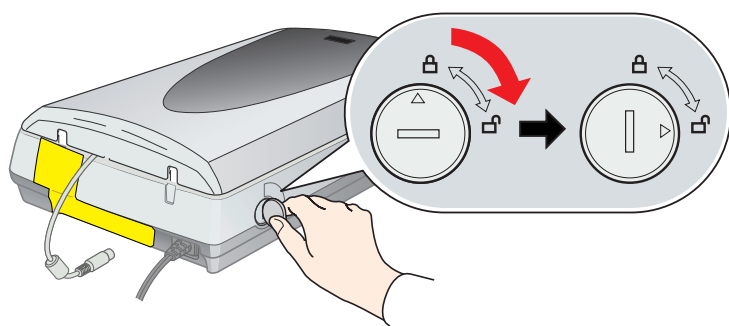

- 2 Remove the sticker from the back of the scanner.

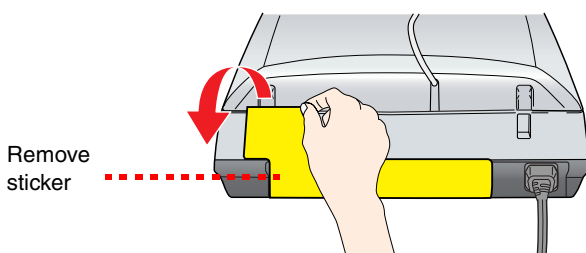

- 3 Connect the cable for the built-in transparency unit (scanner cover). Make sure the notch and arrow on the connector are facing up.

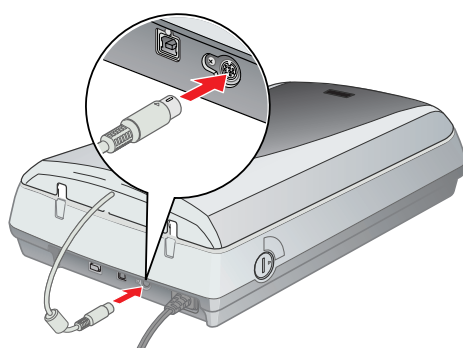

- 4 Connect either the USB cable that came with the scanner or an optional IEEE 1394 (FireWire) cable. **Do not connect both cables.**

If you're using USB

Plug the square end of the USB cable into the scanner's USB port. Then plug the flat end into any available USB port on your computer or hub.

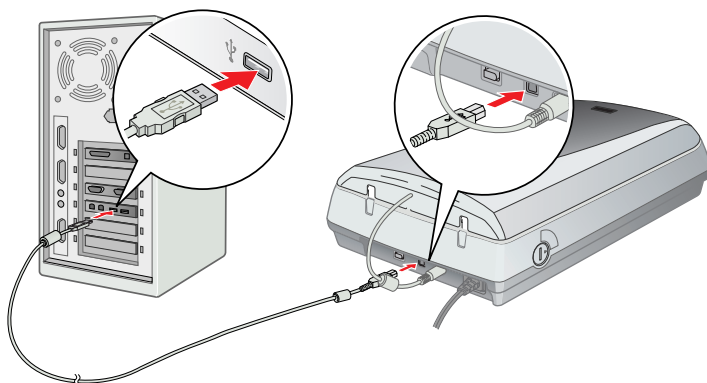

Note: Your scanner may not work correctly if you use a USB cable other than the one supplied by EPSON or if you connect your scanner through more than one hub.

If you're using IEEE 1394 (FireWire)

Plug one end of the IEEE 1394 cable (not included) into the scanner's IEEE 1394 port. Then plug the other end into the IEEE 1394 (FireWire or iLink) port on your computer.

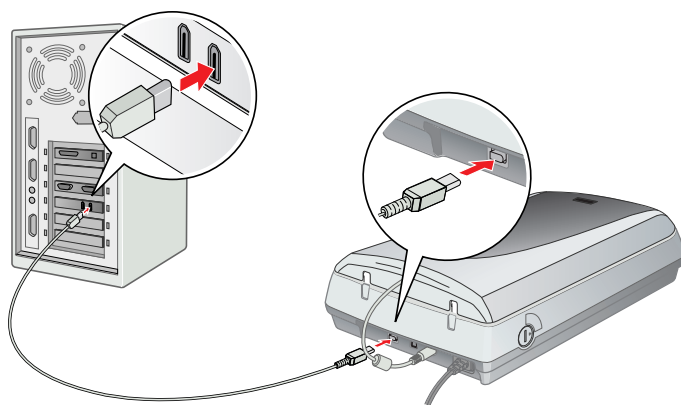

- 5 Plug the scanner's power cord into an electrical outlet.
- 6 Make sure the cover is closed, then press the  power button on the front of the scanner to turn it on.

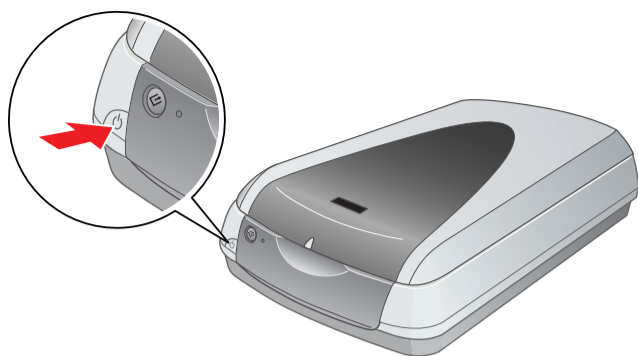

The scanner turns on and the indicator light flashes green. It stops flashing and turns green when the scanner is ready.

Scanner Basics

Scanning With Photoshop

You can import your scanned image into Adobe Photoshop, Photoshop Elements, or another TWAIN-compliant application. You can use the tools in these applications to modify the image before you save or print it.

- 1 Raise the scanner lid and place your photo face down on the glass.



Then close the cover.

- 2 Start Adobe Photoshop Elements.

In Windows, click **Start > Programs** or **All Programs > Adobe Photoshop Elements 2.0**.

On a Macintosh, open the **Adobe Photoshop Elements 2** folder (in your Applications folder) and double-click the **Photoshop Elements 2.0** icon.

- 3 Select **File > Import > EPSON Perfection 4870**.

- 4 EPSON Scan starts, pre-scans, and recognizes the type of image you placed on the scanner, then scans your photo and opens it in Photoshop Elements.

Note: If you don't like the preview, you can use EPSON Scan to fine-tune the image before scanning. See your *Quick Guide* or on-screen *Perfection 4870 Reference Guide* for details.

- 5 Close EPSON Scan. Then use Photoshop Elements to edit, enhance, save, and print your file.

Note: To scan with the SilverFast plug-in, select **SilverFast (Epson-SE)** in step 3 instead of EPSON Perfection 4870. See the SilverFast documentation for instructions on using the plug-in.

Enhancing Your Photos

EPSON Scan includes several features to improve your scans, including DIGITAL ICE™ Technology, Color Restoration, and Dust Removal (for film). For details on using these features, see your *Quick Guide* booklet or on-screen *Perfection 4870 Reference Guide*.

Before and After DIGITAL ICE Technology



Before and After Color Restoration



Before and After Dust Removal

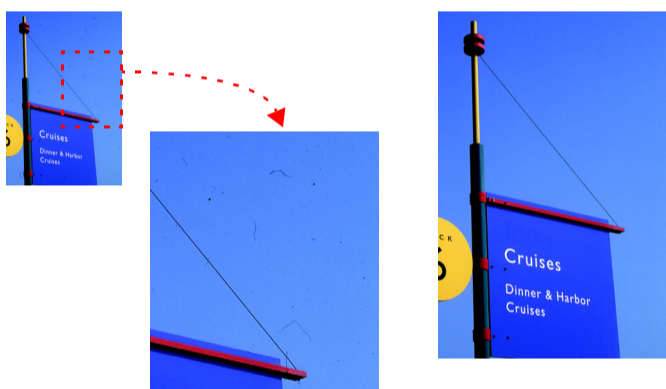

Problems?

First, check the indicator light on the scanner.

<input type="radio"/> Flashing green	Warming up or scanning.
<input type="radio"/> Green	Ready to scan.
<input type="radio"/> Flashing red	Make sure both transportation locks are unlocked. Try restarting your computer and turning the scanner off and then on again. If the red light is still flashing, contact your dealer or EPSON.
<input type="radio"/> Off	Make sure the scanner is connected to your computer and turned on.

If your problem is listed here, try these suggestions.

The New Hardware Wizard appears on your screen.	Click Cancel and follow the steps in “Install the Software” on the other side of this sheet. Disconnect the scanner before installing the software.
The scanner makes a grinding noise when it is turned on.	Make sure both transportation locks are unlocked.
You see a message about a HI-SPEED USB device in Windows XP.	Click the x in the corner of the message to close it. Your scanner will work correctly.
You see an error message when you try to scan, or the scanner doesn't scan.	Make sure the scanner is connected to your computer, plugged into a power source, and the power switch is turned on. Make sure both transportation locks are unlocked.

Questions?

Here's where to look for answers:

Quick Guide

See your *Quick Guide* for instructions on using DIGITAL ICE Technology, scanning film and text, and basic troubleshooting.

On-Screen Reference Guide

Double-click the **Perfection 4870 Reference Guide** icon on your desktop. If you didn't install it, insert the scanner software CD-ROM in the CD-ROM or DVD drive. At the Custom Installation screen, select **Scanner Reference Guide** only, then click **Install**. You must have Microsoft® Internet Explorer, Netscape® Navigator (versions 5.0 or later), or Apple® Safari™ (version 1.0 or later) to read the *Reference Guide*.

On-Screen Help for EPSON Scan

Click the **Help** button or question mark that appears on the screen when you're using these programs.

EPSON Technical Support

EPSON provides technical assistance 24 hours a day through the electronic support services and automated telephone services described below:

- **World Wide Web**
From the Internet, you can reach EPSON Support at <http://support.epson.com>.
- **Automated Telephone Services**
To use Automated Telephone Services, you must have a touch tone telephone and call (800) 922-8911. Your EPSON SoundAdvice™ Express Code is 70490. Use it to quickly select your scanner in SoundAdvice.
- **To Speak to a Customer Service Representative**
Dial (562) 276-4382 (U.S.) or (905) 709-3839 (Canada), 6 AM to 6 PM, Pacific Time, Monday to Friday. Toll or long distance charges may apply.

Before you call, please have the following information ready:

- Product name (EPSON Perfection 4870 Photo)
- Product serial number (located on the back of the scanner)
- Proof of purchase (such as a store receipt) and date of purchase
- Computer configuration
- Description of the problem

Software Technical Support

Software	Telephone*/Fax*	Internet and E-mail
EPSON Scan	U.S.: (562) 276-4382 Canada: (905) 709-3839 6:00 AM to 6:00 PM, Pacific Time, Monday to Friday	support.epson.com
ABBYY FineReader Sprint	(510) 226-6719 fax: (510) 226-6069	www.abbyyusa.com support@abbyyusa.com
Adobe Photoshop Elements	(206) 675-6126 6:00 AM to 5:00 PM, Pacific Time, Monday to Friday (pay support)	www.adobe.com/support techdocs@adobe.com
LaserSoft Imaging™ SilverFast	(941) 383-7496 9:00 AM to 5:30 PM, Eastern Time, Monday to Friday (pay support) fax: (941) 387-7574	www.SilverFast.com support@SilverFast.com

* Toll or long distance charges may apply.

EPSON is a registered trademark of SEIKO EPSON CORPORATION. EPSON Perfection is a registered trademark and SoundAdvice is a service mark of Epson America, Inc.

DIGITAL ICE is a trademark of Kodak.

General Notice: Other product names used herein are for identification purposes only and may be trademarks of their respective owners. EPSON disclaims any and all rights in those marks.

© 2003 Epson America, Inc. 11/03

CPD-16641

Printed in Singapore XXXXXX XX.XX-XX

